

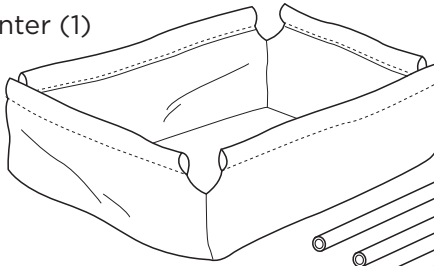

48" x 48" x 12" GEOPLANTER INSTRUCTIONS

GeoPlanter (1)



45" PVC
pipes (4)

3-way
fittings (4)

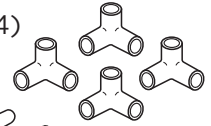

11" PVC pipe
legs (4)

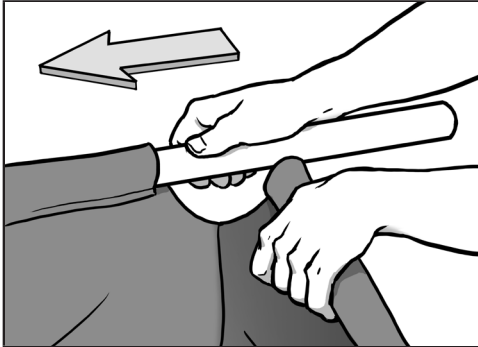

1 Unwrap your GeoPlanter and take the 45" PVC pipes and slide them through the sleeves along the top rails of the GeoPlanter.

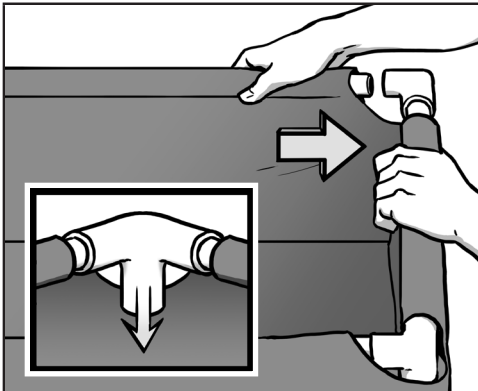

2 Attach the 3-way fittings at each corner, leaving the third open side of the fittings facing down into the GeoPlanter.

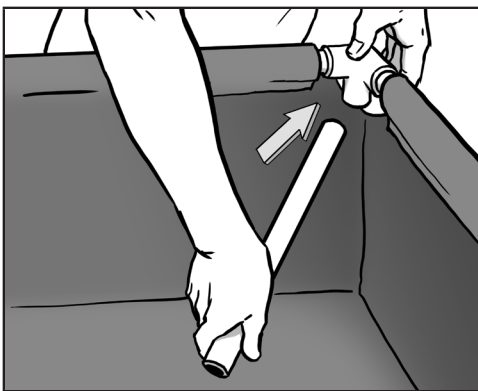

3 Connect the 11" pipe legs to the open sides of the 3-way corner fittings so the legs are standing on the inside of the GeoPlanter.

4 Once attached, ensure that all connections are tight. Place the GeoPlanter on level ground in desired location and fill with soil. If the planter will not be moved or transported on a regular basis, glue may be used to further secure the connections.

Show us what you're growing on Social Media!

 @geopotfabricpots #GeoPots

 facebook.com/geopotfabricpots

For questions or product inquiries, please send an email to contact@geopot.com



48" x 40" x 14" GEOPLANTER INSTRUCTIONS

GeoPlanter (1)

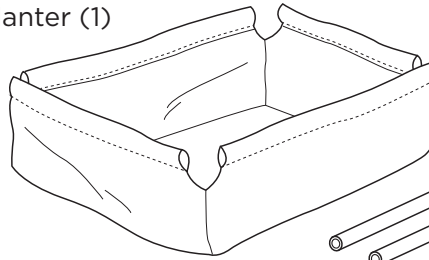

3-way fittings (4)

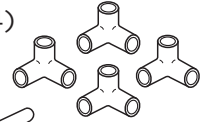

45" PVC pipes (2)

37" PVC pipes (2)

13" PVC pipe legs (4)

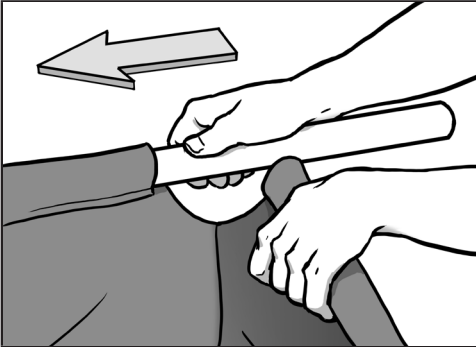

1 Unwrap your GeoPlanter and take the 45" and 37" PVC pipes and slide them through the sleeves along the top rails of the GeoPlanter.

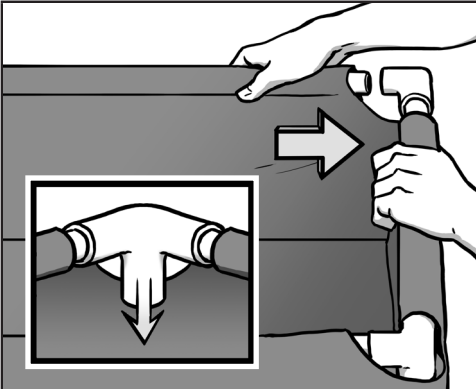

2 Attach the 3-way fittings at each corner, leaving the third open side of the fittings facing down into the GeoPlanter.

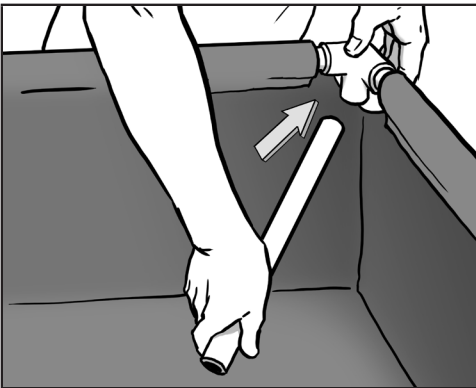

3 Connect the 13" pipe legs to the open sides of the 3-way corner fittings so the legs are standing on the inside of the GeoPlanter.

4 Once attached, ensure that all connections are tight. Place the GeoPlanter on level ground in desired location and fill with soil. If the planter will not be moved or transported on a regular basis, glue may be used to further secure the connections.

Show us what you're growing on Social Media!

 @geopotfabricpots #GeoPots

 facebook.com/geopotfabricpots

For questions or product inquiries, please send an email to contact@geopot.com



36" x 16" x 14" GEOPLANTER INSTRUCTIONS

GeoPlanter (1)

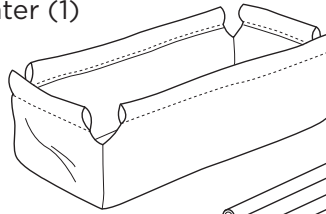

33" PVC
pipes (2)

13" PVC
pipes (2)

3-way
fittings (4)

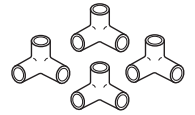

13" PVC
pipe legs (4)

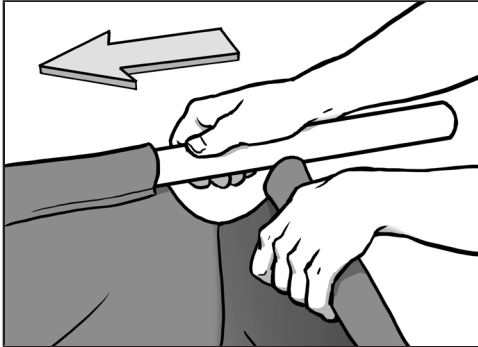

1 Unwrap your GeoPlanter and take the 33" and 13" PVC pipes and slide them through the sleeves along the top rails of the GeoPlanter.

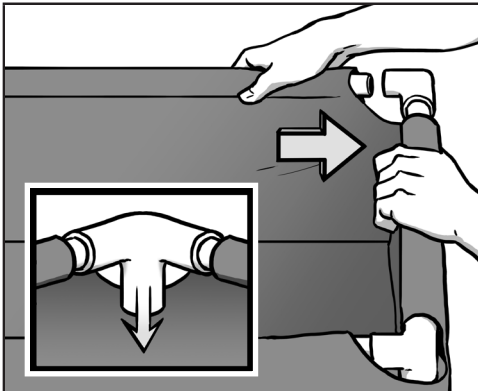

2 Attach the 3-way fittings at each corner, leaving the third open side of the fittings facing down into the GeoPlanter.

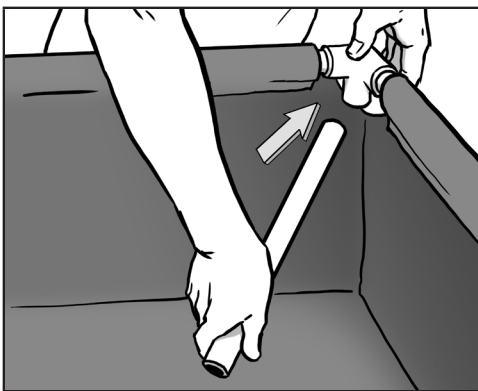

3 Connect the 13" pipe legs to the open sides of the 3-way corner fittings so the legs are standing on the inside of the GeoPlanter.

4 Once attached, ensure that all connections are tight. Place the GeoPlanter on level ground in desired location and fill with soil. If the planter will not be moved or transported on a regular basis, glue may be used to further secure the connections.

Show us what you're growing on Social Media!

 @geopotfabricpots #GeoPots

 facebook.com/geopotfabricpots

For questions or product inquiries, please send an email to contact@geopot.com



48" x 96" x 12" GEOPLANTER INSTRUCTIONS

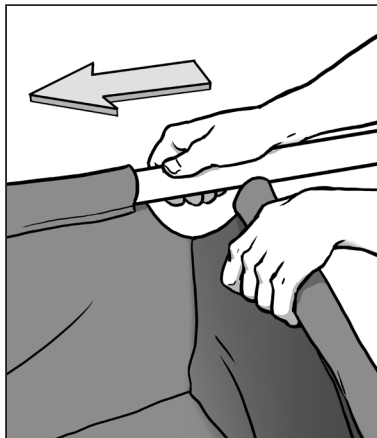
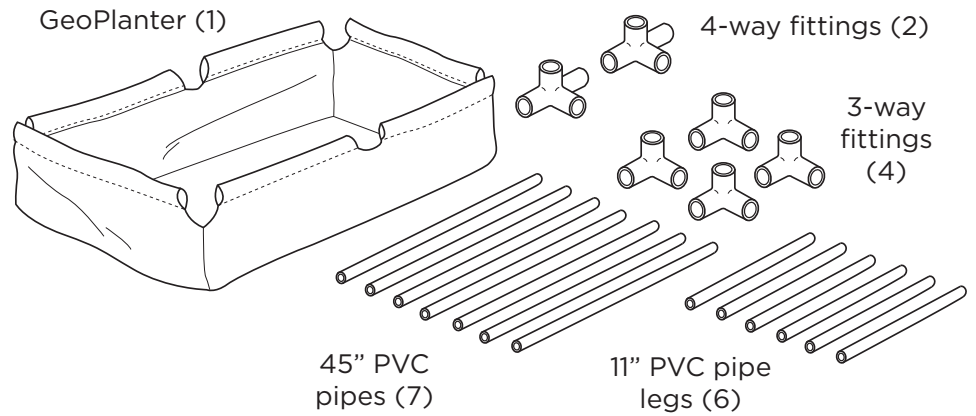

1 Unwrap your GeoPlanter and take the 45" PVC pipes and slide them through the top sleeves of the GeoPlanter.

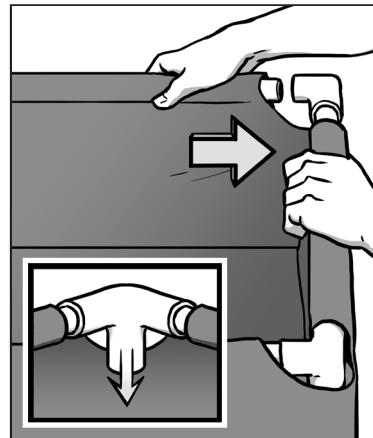

2 Attach the 3-way fittings at each corner, leaving the third open side of the fittings facing down into the GeoPlanter.

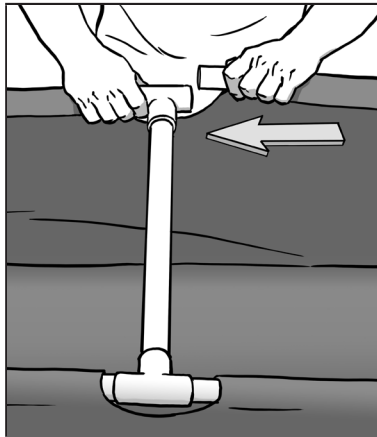

3 Connect the center support pipe with the four way fittings on the ends to the top rail pipe at the center of the GeoPlanter with the open side facing down.

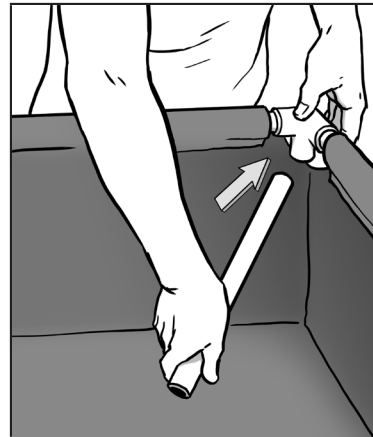

4 Connect the 11" pipe legs to the open sides of the 3-way corner fittings so the legs are standing on the inside of the GeoPlanter.

5 Once attached, ensure that all connections are tight. Place the GeoPlanter on level ground in desired location and fill with soil. If the planter will not be moved or transported on a regular basis, glue may be used to further secure the connections.

Show us what you're growing on Social Media!

 @geopotfabricpots #GeoPots

 facebook.com/geopotfabricpots

For questions or product inquiries, please send an email to contact@geopot.com



72" x 36" x 14" GEOPLANTER INSTRUCTIONS

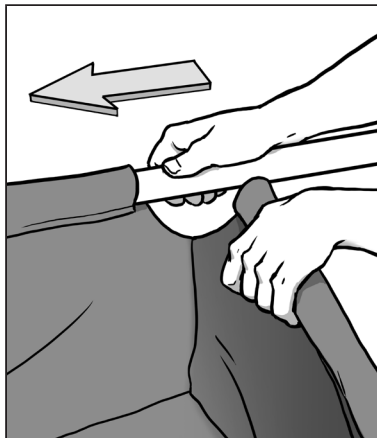
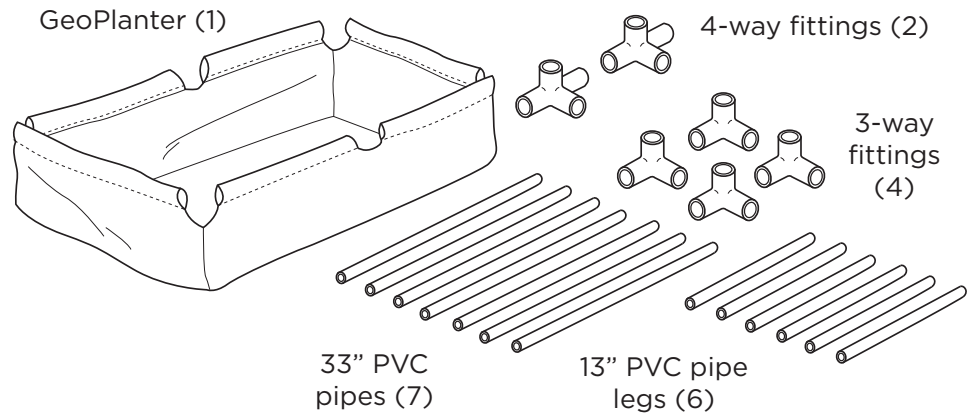

1 Unwrap your GeoPlanter and take the 33" PVC pipes and slide them through the longer top sleeves of the GeoPlanter.

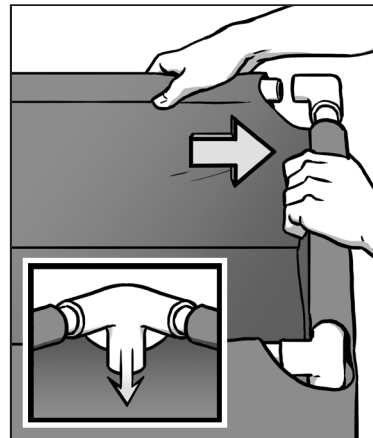

2 Attach the 3-way fittings at each corner, leaving the third open side of the fittings facing down into the GeoPlanter.

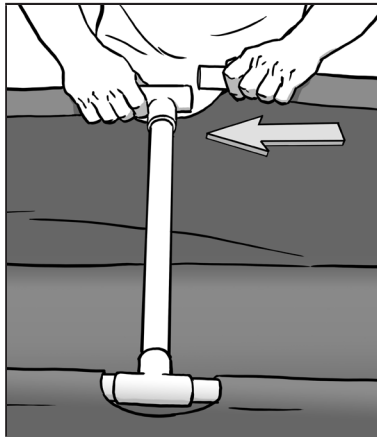

3 Connect the center support pipe with the four way fittings on the ends to the top rail pipe at the center of the GeoPlanter with the open side facing down.

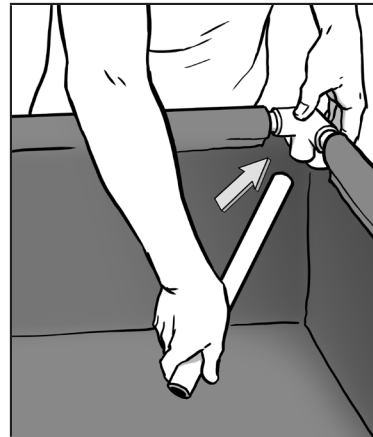

4 Connect the 13" pipe legs to the open sides of the 3-way corner fittings so the legs are standing on the inside of the GeoPlanter.

5 Once attached, ensure that all connections are tight. Place the GeoPlanter on level ground in desired location and fill with soil. If the planter will not be moved or transported on a regular basis, glue may be used to further secure the connections.

Show us what you're growing on Social Media!

 @geopotfabricpots #GeoPots

 facebook.com/geopotfabricpots

For questions or product inquiries, please send an email to contact@geopot.com